



Products for

# Glass / Window / Façade

VITO products for the storage and handling of glass, windows and façade elements



At VITO Irmen, I make sure that all machines run smoothly and precisely at all times.

## VITO Products for Glass / Window / Façade

**The VITO brand stands for comprehensive system solutions within our core competences of sealing, bonding, assembly and protection. Innovative processes and future-orientated developments ensure a smooth execution and a perfect result for the design and the processing sector.**

We supply distance, shipping and spacer pads that meet all the requirements of palletizing, storage and transportation in the markets of insulation glass and window manufacturing, solar energy and construction.

Self-adhesive stamped pieces, sealing and mounting tapes made of cellular foams and other basic components complete our supply program to cover a large range of industrial applications.

To learn more, please visit our website:  
**[www.vito-irmen.de](http://www.vito-irmen.de)**

|   |    |
|---|----|
| Distance and shipping pads                                | 4  |
| Spacers   | 6  |
| Edge protection for fire-protection glass                 | 8  |
| Double-sided adhesive tapes for extruded plastic profiles | 9  |
| Dry glazing for insulation glass windows                  | 10 |
| Structural glazing  | 12 |
| Glazing and sealing tapes for wooden window construction  | 14 |
| Services  | 16 |
| Instructions for the application of adhesive tapes        | 17 |
| We are VITO Irmen   | 18 |



# Stacking made easy

## VITO spacer pads

**Stacking made easy: Our spacer pads function as shock absorbers and anti-skid distance keepers for products made of glass, plastics and metal.**

The different characteristics of cork, hard foam or cellular rubber allow numerous possibilities of application.

They are perfectly suitable for the storage and the transportation of insulation glass units or fully-assembled door and window elements made of plastic or metal. By selecting the appropriate type and thickness of spacer pad it is possible to find a suitable solution for different circumstances and requirements.

We recommend our ready-to-use VITO spacer pads for industrial applications. The VITOKORK SOFT material is available on rolls or bobbins for automatic processing.



VITOFLEX

**Spacer pads made of cellular rubber, slightly adhesive**

- medium load limit
- anti-slip surface
- high shock absorption

The cellular rubber has a good resilience. The adhesive allows an easy removal of the pad.



On roll with paper liner  
20 x 20 / 3, 4, 6 mm



VITOKORK

**Spacer pads made of cork, slightly adhesive**

- high load limit
- even distance keeping
- medium shock absorption

The cork material has a high compression hardness. The adhesive allows an easy removal of the pad.



On roll with paper liner  
18 x 18 / 2, 3, 4, 6 mm  
20 x 20 / 6 mm



VITOKORK SOFT

**Cork spacer with soft foam backing, self-adherent without glue**

- high load limit
- even distance keeping
- medium shock absorption
- self-adherent, without glue
- removable without leaving residues

The combination of cork and foam is particularly suitable for the soft and precise buffering between glass panes.



Loosely poured, in carton  
16,2 x 17,5 / 2, 3, 4 mm  
25 x 24 mm / 3 mm



on roll  
16,2 x 17,5 / 2, 3, 4 mm  
25 x 24 mm / 3mm



on roll with film covering  
16,2 x 17,5 / 2, 3, 4 mm



On roll for Lisecc / Forel automatic applicators  
18 mm tape / 3mm



on bobbin for Lisecc / Forel automatic applicators  
18 mm tape / 3mm



On roll with film carrier, for Lenhardt automatic applicators  
18 x 18 mm, punched pieces 3 mm

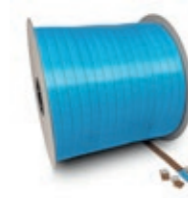

on bobbin with film carrier, for Lenhardt automatic applicators  
18 x 18 mm, punched pieces 3 mm



Please ask for our distance and spacer pad sample card free of charge!

# Keeping a distance

## VITO Spacers

### Self-adhesive spacer pads for the transport and storage of sensitive surfaces

VITO spacer pads function as shock absorbers and anti-slip distance keepers at the same time. Thus, they contribute considerably to cost-reduction and minimization of transport damages.

VITO spacer pads provide troubleshooting for sensitive surfaces. They are perfectly suitable for the stacking and transport of windows.

Delivery forms: one-sided self-adhesive stamped pieces on roll or loosely poured with paper liner.



VITOFLEX

#### Spacer pad for plastic, metal or aluminum surfaces

- cellular rubber
- good inner stability
- anti-slip surface
- medium elasticity
- removable without leaving residues

Dimensions of stamped pieces:  
30 x 30 square  
40 x 40 square

Thickness  
7 and 10 mm



VITOPUR

#### Spacer pads for plastic and metal surfaces

- recycled polyurethane foam
- high load capacity
- also suitable for window frames with a surface protection film-covering
- anti-slip surface
- removable without leaving residues

Dimensions of stamped pieces:  
40 x 40 square

Thickness  
7 and 10 mm



VITOLEN

#### Spacer pad for wooden and plastic surfaces

- Chemically cross-linked polyolefin foam
- Slightly adhesive
- Removable without leaving residues
- no discolouration of the surface

Dimensions of stamped pieces:  
40 x 40 square

Thickness  
10 and 15 mm



VITOKORK

#### Spacer pad for plastic surfaces with protective film

- ground, agglomerated cork
- high load capacity
- strongly adhesive, for application on protective film
- can be glued one on top of another to bridge greater distances

Dimensions of stamped pieces:  
30 x 30 square

Thickness  
6 mm

Please ask for our distance and spacer pad sample card free of charge!



The given data and facts are based on results from carefully carried out tests and practical experience. Nevertheless, these indications do not exonerate the user from the necessity of carrying out their own suitability test in relation to the particular application, especially for any other kind of different applications. Spacer pads must only be applied on dry, fully cured surfaces. Dimensional data are only approximative (die-cut tolerances according to DIN 7715 - P3). Special versions and dimensions upon request.

## Protection against breakage and fire

### VITOMINIUM PET 230

#### High-quality, self-adhesive edge protection tape for insulation and fire protection glass

VITOMINIUM PET 230 is an edge protection and sealing tape made of a combination of aluminium and polyester. It functions mainly as a protection and additional vapour barrier on the edge of insulation glass panes and fire protection glass units.

Furthermore, it serves the sealing and protection of sensitive components and surfaces, as a diffusion barrier against humidity and heat, to cover connections and but joints in the manufacture of solar modules, as well as in heating and ventilation systems.

Due to its flexible and high-quality acrylate adhesive, VITOMINIUM PET 230 can be easily applied on even as well as rough surfaces.

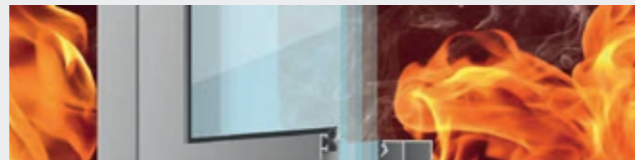

- high adherence on glass, metal and PVC
- high initial tack
- vapourtight
- excellent mechanical stability
- UV resistant

| Product properties                      |  |
|---|--|
| Carrier                                 | composite aluminum / PET   |
| Adhesive                                | modified acrylic   |
| Thickness of aluminium                  | 0,05 mm  |
| Thickness of PET film                   | 0,05 mm  |
| Total thickness                         | 0,23 mm  |
| Protective liner                        | siliconized paper, white   |
| peel adhesion acc. to DIN EN 1939:1996  | on steel at 20 °C 25 N / 25 mm   |
| shear adhesion acc. to DIN EN 1943:1996 | on steel at 20 °C 20 N/625 mm <sup>2</sup><br>at 50 °C 5 N/625 mm <sup>2</sup> |
| Temperature resistance                  | -40 °C to 90 °C  |



### VITOMOUNT 125 mounting tape for Georgian bars

## Give more profile to your windows

#### Double-sided self-adhesive tape for the mounting of Georgian bars made of plastic, wood and metal

The VITOMOUNT Georgian bar mounting tape is made of a closed-cell polyethylene foam and equipped on both sides with a special acrylic adhesive. The initial tack and permanent adhesive power which is required for the mounting of Georgian window bars is achieved through the VITOMOUNT Georgian bar mounting tape, so that a subsequent sealing with elastic sealing compounds can be carried out without any problem.

The Georgian bar mounting tape is suitable for indoor and outdoor use. The application temperature should be between 18°C and 30°C. Please observe our application instructions for adhesive tapes.

We supply VITOMOUNT Georgian bar mounting tape in different thicknesses for the mounting of Georgian bars of different materials. For the mounting of wooden bars, we recommend a minimum thickness of 2 mm.

Basically speaking, the subsequent sealing of the gap between the glass and the wooden Georgian bars reflects the present state of the art. As the wooden bars are usually designed with a groove, a bevel or similar, the clean subsequent sealing can be carried out without any problem. As far as the mounting of PVC or metal bars is concerned, the same conditions apply. However – depending on the design – it can be possible to use tapes with a thickness of less than 2 mm.

VITOMOUNT Georgian bar mounting tapes can be supplied on rolls or bobbins. Due to their great length, the tape on bobbins is especially useful for the automatic application. The bobbins assure a high productivity of your process – up to the very last metre of tape.



### VITOMOUNT 125 SSPPR - 70 PLG 1

#### Designed for the mounting of Georgian bars made of plastic and metal on glass, for indoor and outdoor application.

- For bars with co-extruded sealing lips, a subsequent sealing of the joint is not required (test report of the external inspection laboratory) IFT Rosenheim.
- For bars without co-extruded sealing lips, a subsequent sealing of the joint is required (test report of the external inspection laboratory) IFT Rosenheim.

**Thickness: 1,0 mm** - white or black

**Thickness 1,6 mm** - white or black

Bobbins with thickness 1,0 mm and standard widths can be delivered from stock.

### VITOMOUNT 125 S - 30 FBL 2

#### Georgian bar mounting tape with high initial tack and high permanent adhesion, for the application of wooden Georgian bars, for interior and exterior application with subsequent sealing

**Thickness: 2 and 3 mm** - white or black



# Things to know about dry glazing

## VITOMOUNT 125 DG 75 FBL2

**Putting an end to glazing spacers and wet bonding: Use the advantages of the VITO dry glazing of insulation glass windows.**

The adhesive tape is applied to the frame profile. The dry bonding system connects the insulation glass pane with the window frame to form a stable, static unit. Depending on the size of the window, a steel core may not be required. The window becomes lighter, the stress on the fittings is reduced. The adhesive tape can be applied inline onto the extruded profiles. It can endure further processing operations such as bevel cutting, welding, and milling without any problem. The liner protects the tape against dirt.

The tape can be also applied directly onto the finished frame in the window production plant. The VITO Dry Glazing system can be

adopted in the production line easily and without additional investment. No extra curing time is required; the window is immediately ready for transport and installation. Defective glass panes can be replaced easily.

A test certificate from the IFT Rosenheim / Institut für Fenster-technik Rosenheim) is available.

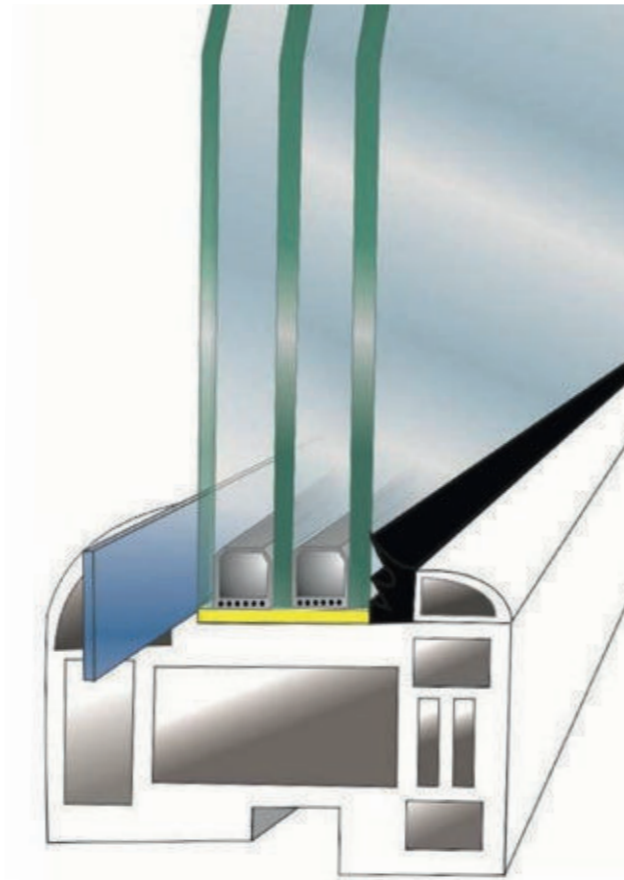

VITOMOUNT 125 DG 75 FBL2

### The tape for the dry glazing of insulation glass windows

| Product properties                               |          |  |                            |
|--|----------|--|----------------------------|
| Thickness  |          |  | 1,6 mm                     |
| Colour   |          |  | black                      |
| peel adhesion on steel acc. to DIN EN 1939:1996  | at 20 °C |  | 26 N / 25 mm               |
| shear adhesion on steel acc. to DIN EN 1943:1996 | at 20 °C |  | 60 N / 625 mm <sup>2</sup> |
| Thermal conductivity ISO 8301                    | at 10 °C |  | 0,038 W/m <sup>2</sup> K   |
|  | at 20 °C |  | 0,041 W/m <sup>2</sup> K   |
| Temperature resistance                           |          |  | -40 °C to 100 °C           |
| Processing temperature                           |          |  | 15 °C to 30 °C             |

## Comparison of glazing methods

### Glazing method using glazing spacers

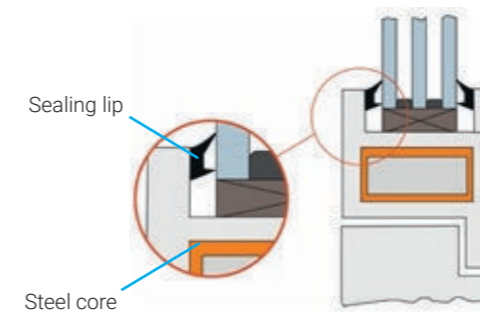

### Advantages of VITO Dry Glazing of insulation glass units versus glazing with spacers only

- Increased stability
- Better statics
- Higher rigidity
- Improved energy efficiency
- Higher resistance against distortion
- Higher dimensional accuracy
- Increased safety against burglary
- More design options
- Allows larger and leaner designs

### Wet bonded glazing

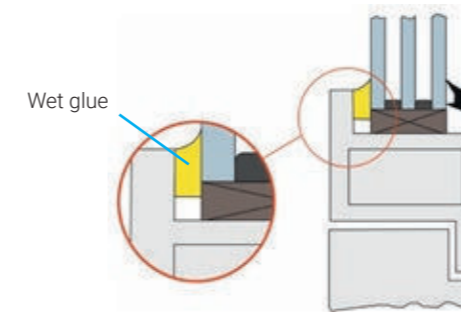

### Advantages of VITO Dry Glazing of insulation glass units versus wet bonded glazing

- Time saving
- Cost saving
- Easier replacement of panes
- Easier mounting

### VITO Dry Glazing

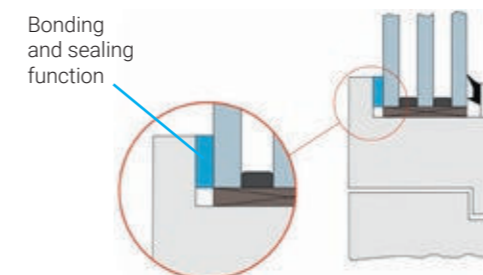

### Convincingly simple: Dry Glazing by VITO

Besides the safe statics, there is the advantage that the sealing and bonding functions are combined in one process. The usual manufacturing process remains almost unchanged; there is no need for further investment. Depending on the size of the window, a steel core may not be required, which provides improved thermal insulation. Windows can be built with new designs.



# Small Tape – Big Effect

## VITO Glazingmount 400

### Self-adhesive polyurethane foam used as a spacer tape for the assembly of Structural Glazing façade elements

VITO Glazingmount 400 consists of a high-density polyurethane foam. This quality is equipped on both sides with a high-performance acrylate-based adhesive.

This product is especially designed – as a spacer tape – for the assembly and mounting of structural glazing systems for glass façades.

VITO Glazingmount 400 is also applied in the construction of façades, halls, conservatories, the fitting of windows and as spacer and vibration absorbing system for a large variety of applications.

The use of high-grade pure acrylic adhesives ensures excellent shear resistance on surfaces consisting of glass, steel and anodized aluminium. The tape is characterized by an excellent resistance against weathering and UV radiations.

| Delivery specifications   | width mm | number of rolls per production unit |
|---|----------|-------------------------------------|
| VITO Glazingmount 400   | 6        | 50                                  |
| Anthracite – double-sided adhesive                                | 9        | 36                                  |
| Adhesive sides black  | 12       | 25                                  |
| Liner: PE-film, blue  | 15       | 20                                  |
| Thickness 3,2 / 4,8 / 6,4 and 8,0 mm                              | 19       | 17                                  |
| Length of roll, according to the different dimensions: 10 to 15 m | 25       | 13                                  |

The products are also available in a single-sided adhesive version and as stamped pieces.

VITO Glazingmount 400 has been especially designed as a spacer device. The particularly good adhesive properties must not lead to its exclusive application of a permanent mounting system or to the reduction of the silicone quantities recommended by silicone producers. The indication concerning technical data corresponds to the average values obtained during the production process at the printing time. These data constitute no specification and do not signify any assurance of certain properties of the products or their suitability for a concrete application. We recommend that you carry out your own tests.

With a K-value (thermal conductivity acc. to DIN 52612) of only 0,082 W / m2 K, the Glazingmount 400 tape contributes considerably to a high thermal insulation.

VITO Glazingmount 400 is compatible with different tested silicones. The pertinent certificates of the silicone producers are available on request.

VITO Glazingmount 400 is successfully tested as a distance tape for structural glazing by the Institut für Fenstertechnik in Rosenheim, Germany (ift test report 507 20370 from 20.08.1998)



**Structural Glazing (SG) or Structural Sealant Glazing (SSG) is a type of glass façade construction in which glass panes are held in place exclusively by adhesives. Pressure bars can be omitted. Wind, suction and earthquake loads are absorbed by the bonding. The dead load of the panes is transferred by a concealed mechanical device.**

**All sealing profiles must be made of silicone or silicone-compatible material.**

**Attention must be paid to the compatibility of laminated glass layers (PVB / Polyvinylbutyral) and silicone. For facade heights of 8 m and more, structural glazing facades are only permitted in Germany with an additional surrounding retaining profile, which is intended to prevent the panes from falling out if the bonding fails (redundancy).**

**Structural glazing facades without approval are not regulated building products and are only approved with a test certificate or approval in individual cases.**

## Durably Tight: VITO Glazing Tapes

VITOLEN / VITOGLAS / GLASERFIX

VITO glazing tapes are made of a closed cell PET-Foam equipped on one side with a special environmentally-friendly, pressure-sensitive glue. The elasticity of the VITO glazing tapes compensates the movements caused by wind load stressing as well as by changes in temperature and humidity. These may occur at different speeds and may overlap.

Suitably applied and in conjunction with commercially available elastic sealing materials, VITO glazing tapes ensure closed glazing joints which are characterized by efficient weathering resistance. Produced in the mentioned way, the durably elastic glazing joint performs its function for many years.

A positive effect obtainable through the use of glazing tapes is the improved isolation against transmission of noise. Our glazing tapes are free from softening agents. They can be used within a temperature range extending from -80 °C up to 50 °C. Compatibility with commercially available elastic sealing materials is given. High adhesive strength and shearing strength guarantee a stable adhesive cohesion power.

Only in case of uneven and porous substrates, a preliminary undercoat (primer) is recommendable in order to achieve a good adherence. But normally our glazing tapes do not need a preliminary undercoat. The glazing joint must be dry and exempt from any separating agents and dust. The recommended temperature of application is between 18 °C and 30 °C.

According to instructions given by the Institut für Fens-tertechnik e.V. in Rosenheim and the Glasfachschule in Hadamar, the glazing tapes should be inserted not only towards the outer side, but also towards the inner side of the room (please refer to the diagram). This mode of application serves the better application of elastic sealing materials. Up to stress group 4 it is recommendable to use VITOGLAS 120 and VITO GLASERFIX 111. From stress group 5, the use of a special glazing tape is necessary. In this case we recommend VITOGLAS 110.

Glazing tapes made of polyethylene foam may not be exposed to direct solar radiation, because the surface layer of the material could be damaged by the high ultraviolet load. VITO sealing and glazing tapes are available in different versions.

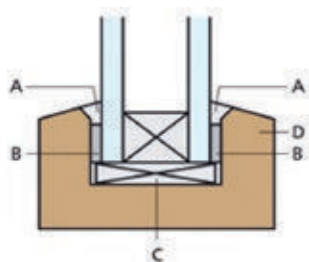

A = Sealing with elastic sealant  
B = VITO Glazing Tape  
C = Glazing block  
D = Glazing bar

| Delivery Specification  | width in mm                                       | thickness in mm | length in m | number of rolls per dispatch unit |
|---|---|-----------------|-------------|-----------------------------------|
| <b>VITOGLAS 120</b>   |   |                 |             |                                   |
| 10 rolls in shrink pack   | 9   | 2 to 4          | 20          | 100                               |
| colour: white and black   | 9   | 5 and 6         | 10          | 100                               |
| Liner: PE-film, fibre-reinforced, white   | 12  | 2               | 20          | 80                                |
|   | 12  | 6               | 10          | 80                                |
|   | 15  | 3               | 20          | 60                                |
| <b>VITOGLAS 120 bobbin</b>  |   |                 |             |                                   |
| colour: white and black   | 9   | 3               | 480         | 12                                |
| Liner: PE-film, fibre-reinforced, white   | 9   | 4               | 360         | 12                                |
| <b>GLASERFIX 111</b>  |   |                 |             |                                   |
| 10 rolls in shrink pack   | 9   | 2 to 4          | 25          | 100                               |
| colour: white and black, without liner, adhesive on inner side, with reinforcement against overstretching | 9   | 6               | 10          | 100                               |
|   | 12  | 2 and 3         | 25          | 80                                |
| <b>VITOGLAS 110</b>   |   |                 |             |                                   |
| colour: black and white   | dimensions upon request, as manufactured to order |                 |             |                                   |
| Thickness: 2 to 8 mm  |   |                 |             |                                   |
| liner: PE-film, white   |   |                 |             |                                   |



VITOGLAS 120

**The VITOGLAS 120 glazing tape is deliverable with a PET-foil covering and a thread-reinforcement. Prior to the mounting, this protective foil must be removed from the outer adhesive layer.**

VITOGLAS 120 is deliverable in shrink packs ready for processing. The application ensues in a practical and economical way, directly from the pack, that means from the roll core.

The VITOGLAS 120 BOBBIN is convenient for wholesalers and for industrial use when manufacturing windows. Continuity of the production flow and economical application up to the last metre are guaranteed.



on roll



on bobbin



GLASERFIX 111

**GLASERFIX 111 has proven itself on the market as an environmentally friendly alternative.**

This glazing tape is supplied with an inner adhesive layer and therefore avoiding any removal and disposal of a protective foil covering.

The polyethylene foam of the VITO GLASERFIX 111 glazing tape is firmly laminated with a PET-foil covering which functions as a reinforcement against overstretching.

The adhesive layer without protective film is not only an advantage with regard to environmental protection. It also allows a quick application and increases the internal stability of the roll winding.



on roll, colours white and black



VITOGLAS 110

**The high and permanent weight load associated with the glazing of roofs requires the use of VITOGLAS 110.**

The tape is characterized by high stability and internal strength.

In this field of application a higher temperature load is to be expected. For reasons of a better heat dissipation we recommend choosing the colour black.



on roll





## A large variety of products

Our adhesive tapes can be used for a wide variety of applications, depending on the type of tape and adhesive.

Please ask us if you are looking for an appropriate product to suit your particular application or use our "Tape Selector" on our website:

[www.vito-irmen.de](http://www.vito-irmen.de)



## Individual roll widths

You need a different roll width? We cut the rolls for you to the desired width, starting from 6 mm width (depending on the product).



## Standard die-cuts

Your adhesive tape should be a punched tape? Round, oval, square, with a finger lift or loosely poured in bulk? We die-cut your roll on our roll die-cutting machine individually, efficiently, and according to your specification.



## Die-cutting any shape according to custom design

You require a self-adhesive product in a special shape? Upon request we supply to you custom-made die-cuts according to your CAD-drawing: sheets or strips, non-adhesive, one-sided or double-sided adhesive.

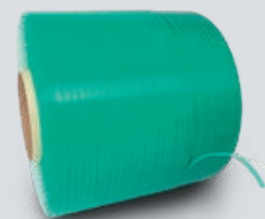

## Bobbins and rolls with great lengths

We can supply some of our products also as bobbins or rolls with great lengths, for automatic processing. The great lengths allow you to minimize the set-up times of your machines.

# Instructions for the application of adhesive tapes

### General guidelines

These instructions are to be seen as guidelines for the user of adhesive tapes. They provide useful information for an optimum application. Should this information not be sufficient for your application, or should you require further guidance, we should be glad to advise you.

### Application temperature

The most favourable application temperatures (object- and application temperature) are between 15 °C and 30 °C. Bonding below 15°C temperatures is not recommendable. Exceptions are possible only for tapes with special types of adhesives that can be applied even at low temperatures.

### Please note:

- Below the recommended application temperature, the adhesive can become too hard. As a consequence, the optimal adhesion values will not be achieved.
- When moving the adhesive tape from a cold to a warmer place, ensure that there is sufficient time for acclimatization to avoid condensation on the surface. The same applies to the substrates which are to be bonded.

### Surface cleaning

In order to achieve and use with optimal effect the properties indicated in the technical data sheet, the surfaces to be glued must be dry and clean (remove dust, grease, humidity). Cleaning substances should comprise compatible solvents, for example, benzine or alcohol. Please observe the manufacturers' corresponding safety precautions. The cleaning cloth must be clean and exempt from lints and can be used once only. Do not touch the adhesive surface after cleaning.

### Surface condition

Good adhesions can be attained on smooth surfaces and surfaces with a high surface energy; whereas rough surfaces require a thicker adhesive layer. Non-critical substrates are metals, glass, rigid PVC, polycarbonate and ABS. More critical substrates with a low surface energy are polypropylene and polyethylene; powder paint, rubber, plastics equipped with lubricants, teflon and silicone.

### Please note:

- Porous surfaces (for example, concrete) or fibrous materials (for example, wood) require a sealing of the surface before bonding.
- Adhesions on soft PVC require a primer or special adhesive tapes, in order to reduce the migration of plasticizers.

### Pressure

Firmly press the adhesive tape onto the surface using a roll or a scraper. Hard adhesives require a higher application pressure than soft adhesives, in order to develop the necessary adhesive strength.

### Load

In general, any designs must be avoided that produce a delamination load or peeling force. Shearing and tensile loads must be distributed over the entire adhesive surface. Tensions at the end sections of the assembling elements must be avoided.

### Please note:

- Permanent tensions impair the stability of the adhesion.
- The adhesive tape should not be charged with a mechanical load earlier than 24 hours after the application.

### Storage

The material is to be stored in the original cardboard box at room temperature and a relative humidity of about 60% and must be protected against direct UV radiation. The storage life is indicated in the corresponding technical data sheet.

### Verification of suitability

All indicated details and technical information are based on laboratory examinations or specifications of our suppliers. All these details and information have been determined to the best of our knowledge. However, a guarantee regarding the respective completeness and correctness is excluded. Prior to the use of our product, it is necessary to check the suitability for the intended purpose of application. Questions relating to guarantee and liability for this product are regulated in our general business terms, unless legal regulations provide other relevant stipulations.





1963: The first coating line



2022: Roll-production with high-tech machines

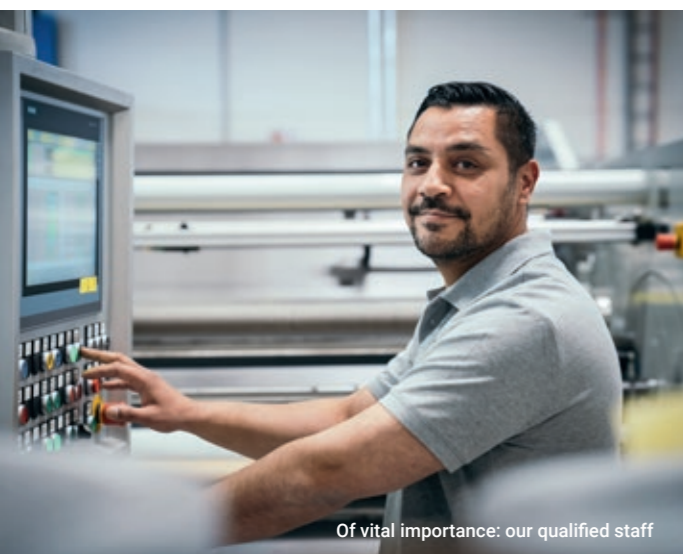

Of vital importance: our qualified staff



Quality control in our own laboratory

## VITO Irmén Quality since 1907

**On March 12th, 1907, Alfred Irmén establishes in Weißen-thurm the technical wholesale trade with chemical-technical products. The beginning of a long company history.**

In 1913, the company moves to Remagen, where its head-quarters are still based today. During the 1950s, the portfolio changed from felt products to polyethylene foams which were laminated with felt. After being coated with a one-sided self-adhesive layer, this material served as spacers. Metal and plastic foils supplemented the portfolio – a range that now also attracted attention on an international level.

The big seller at the time was „VITOPLAST - against drafts, dust and door slamming.“ The product made many a draughty apartment feel more comfortable. With the first coating plant in 1962, rolls could be coated in an economical way.

**VITO Irmén today: production on more than 15.000 m<sup>2</sup> of space**

Today VITO Irmén produces on the most modern coating, stamping, winding and cutting machines a large portfolio of self-adhesive products for applications in industry, glass/windows/facades, construction, automotive, medical technology and renewable energies. With the building of a new production and warehouse facility in Remagen with more than 6,000 m<sup>2</sup> of production and storage space we are well prepared for future requirements.

## Put to the test every day

**You can rely on us: Our products are subject to constant quality controls.**

You can only grant a warranty to your customer if you can rely on the products of your own supplier.

All our adhesive products not only comply with the high German manufacturing standard, but also to the specified DIN and ISO standards.

To prevent variations in quality, all production batches are tested in our laboratory for the various properties: shear and tensile behavior, temperature properties and more. Please note our application instructions on page 17.

## Further catalogues

### Construction



Sealing Tape

Partition wall tape

Nail sealing tape

Joint sealing tape (pre-compressed)

Self-adhesive sealing tapes for heating – ventilation – air conditioning

Mirror mounting tape

Mirror mounting brackets

### Industry



Double-sided adhesive foam tapes

Adhesive transfer films

Sealing – insulation – protection

### Automotive

### Medical technology

### Renewable energies

[www.vito-irmen.de](http://www.vito-irmen.de)





**VITO Irmén GmbH & Co. KG**

**Postal address** Postfach 1720 · D-53407 Remagen · Germany

**Factory 1 / Office** Mittelstrasse 74-80 · D-53424 Remagen · Germany

**Factory 2** Robert-Bosch-Strasse 1 · D-53424 Remagen · Germany

+49 2642 4007-0

sales@**vito-irmen.de**

Your contact person / specialized dealer

